

# Data Sheet



Article number: 2301072961

Description: E+G Handwheel  
VDS.300+I-A20

## Measures

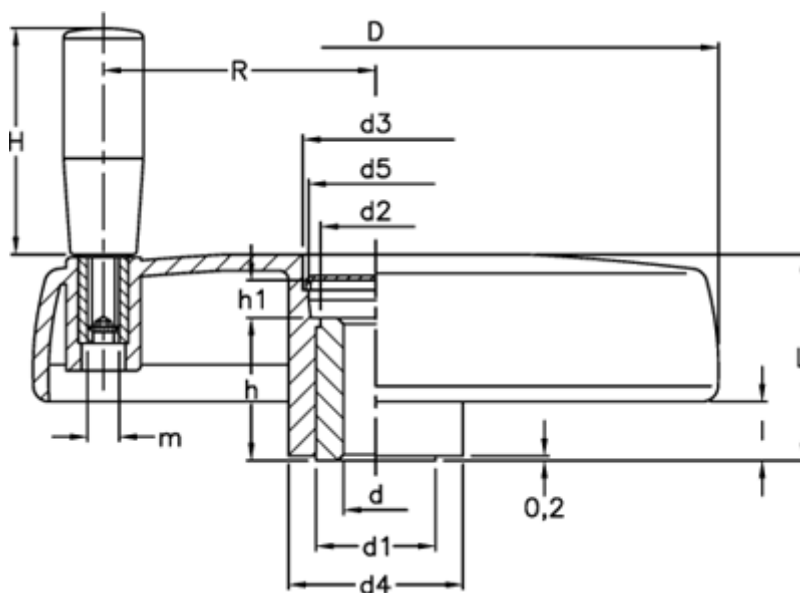

C (N m) = 500	H = 90
D = 300	h = 44
d1 = 40	h1 = 20
d2 = 36.5	l = 20
d3 = 68.5	L = 66
d4 = 72	L (J) = 30
d5 = 66	m = M10
d H7 = 20	R = 124.0